

SMART HOME STORAGE BATTERY

WALL MOUNTED VERSION

48V 200AH

智能家居蓄电池(壁挂式)

INTRODUCE 简介

Wall mounted Lithium battery is with a ground-breaking battery pack solutions are highly integrated, deep cycle backup power solutions for your solar home energy storage system. With rich experience and advanced techniques, the product has the features of the fashionable design, high energy, high power density, long service life, and easiness of installation.

壁挂式锂电池采用突破性的电池组解决方案,是高度集成的深循环备用电源解决方案,适用于您的太阳能家庭储能系统。凭借丰富的经验和先进的技术,该产品具有设计时尚、高能量、高功率密度、使用寿命长、安装方便等特点。

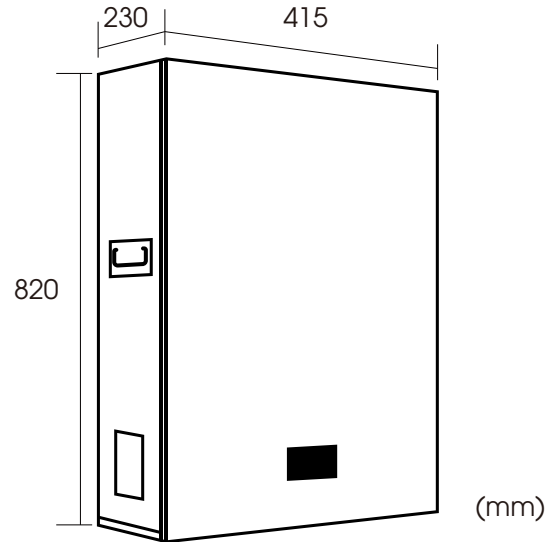

FEATURES & BENEFITS 功能和优点

- ◆ **Quick Installation and Uninterruptible Maintenance**
快速安装和不间断维护
- ◆ **Wall Mounted, Flexible Extension Life Time**
壁挂式, 灵活延长使用寿命
- ◆ **Safety Protection and Rasy Move**
安全防护, 轻松行动
- ◆ **4,000 Cycles at 90%DOD**
90%DOD时的4000次循环
- ◆ **Safe and Reliable**
安全可靠
- ◆ **IP40 Protection**
IP40防护
- ◆ **Flexible Size**
灵活的尺寸

APPLICATION SCENARIO 应用场景

- ◆ **Family**
家庭
- ◆ **Small industrial business district**
小型工业商业区
- ◆ **Solar energy storage system**
太阳能储能系统
- ◆ **Farm**
农场
- ◆ **Remote suburbs**
偏远郊区
- ◆ **Small Wind Energy Storage System**
小型风能储能系统

SPECIFICATIONS 规格

MODEL:48V200Ah

Battery Type 电池类型	LiFePO4
Battery rated capacity (Ah) 电池额定容量(Ah)	200
Battery rated voltage (V) 电池额定电压(V)	51.2
Battery working voltage (V) 电池工作电压(V)	40~58.4
Communication method 通讯方式	CAN/RS232/RS485
Continuous charging current (A) 持续充电电流(A)	100
Continuous discharge current (A) 持续放电电流(A)	100
Peak charging current (A) 峰值充电电流(A)	110
Peak discharge current (A) 峰值放电电流(A)	110
The number of batteries allowed to be connected in parallel 允许并联电池数量	32
Waterproof level 防水等级	IP40
Charging temperature 充电温度	0°C ~ 60°C
Discharge temperature 放电温度	-20°C ~ 60°C
Cooling method 冷却方式	Natural Cooling 自然冷却
Display screen 显示屏	LCD

APPEARANCE SPECIFICATION 外观规格

Dimension(L x W x H mm) 尺寸(长 x 宽 x 高 mm)	820 x 415 x 230 mm
---	--------------------

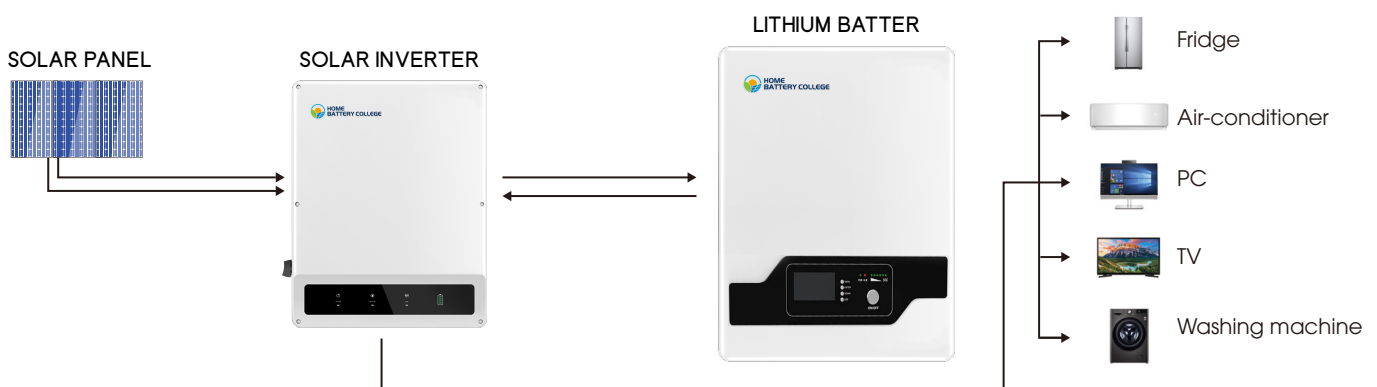

BATTERY CHARACTERISTICS 电池特性

◆ Different current/Temperature Discharge curves

不同的电流 / 温度放电曲线

Different Rate Discharge Curve @25°C

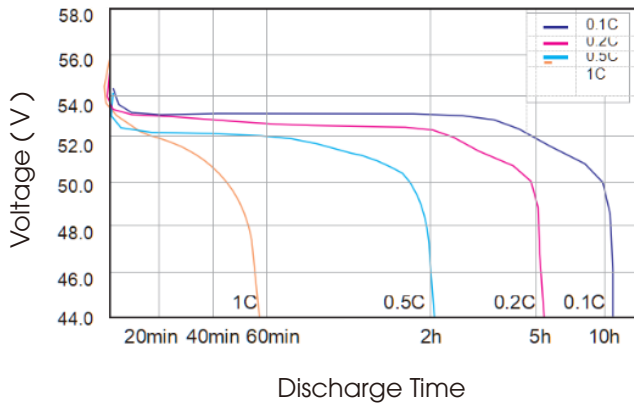

Different Temperature Discharge Curve @0.5C

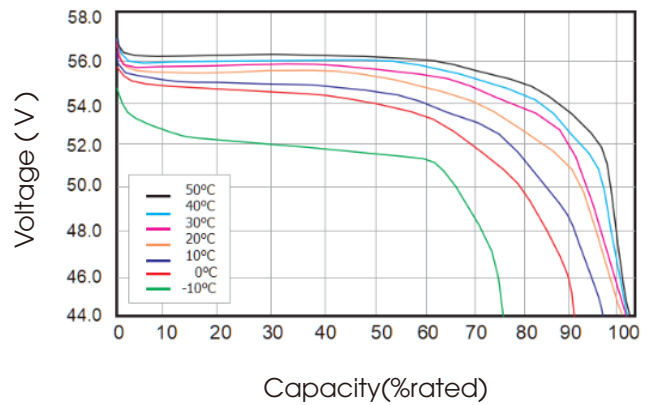

◆ Charging and Discharge curve

充放电曲线

Charge and Discharge at 25°C, 0.5C

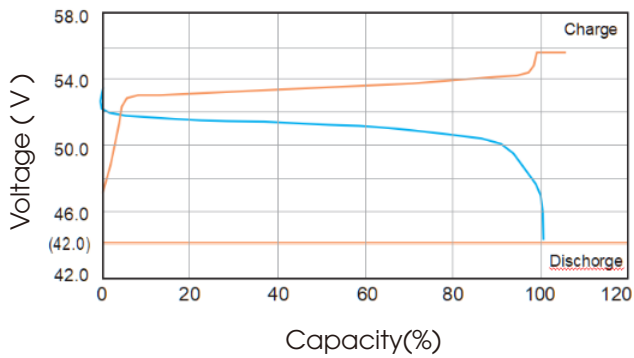

Different Temperature Self Discharge Curve

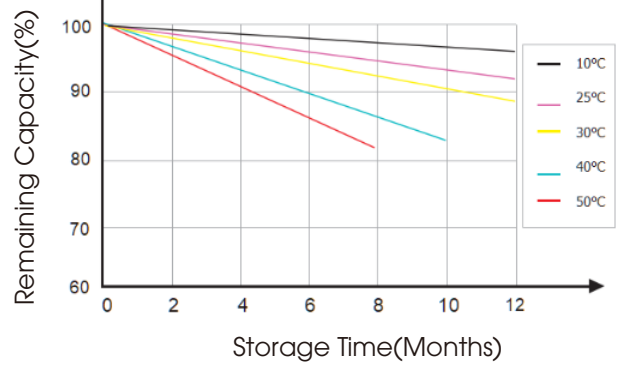

◆ Cycle Life Curve

循环寿命曲线

Different Discharge Depth Life Curves & 25°C, 0.5C

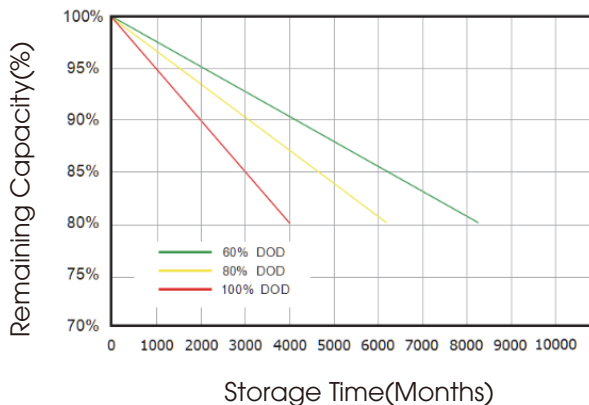

Different Discharge Depth Life Curves & 40°C, 0.5C

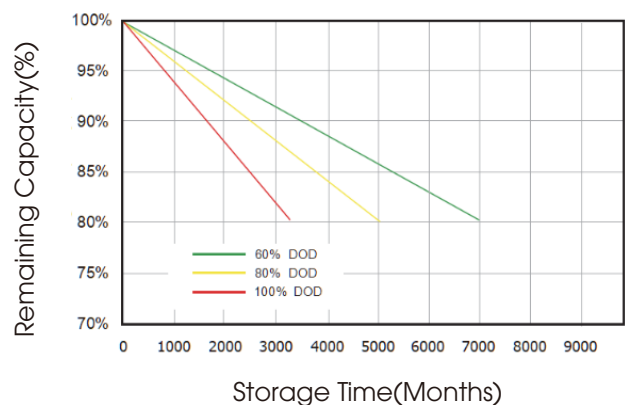

AUTHENTICATION 认证



MSDS



CERTIFIED
UL 1973
UL 9540A

STORAGE 储存

- ◆ Avoid storing in high or low temperature environments, preferably between 15°C and 25°C.
避免存放在高温或低温环境中, 温度最好在 15°C~25°C 之间。
- ◆ When storing, it is important to avoid external vibrations and collisions as much as possible to avoid short circuits inside the battery or damage to the metal casing.
存放时应尽量避免外力的振动和碰撞, 以免造成电池内部短路或损坏金属外壳。
- ◆ It should be stored in a dry and ventilated place, away from sources of ignition, direct sunlight, and humidity. Moisture-proof preservatives or desiccants can be used.
需存放在干燥通风的地方, 远离火源、日光直射和潮湿, 可以使用防潮保鲜剂或干燥剂。

TRANSPORT 运输

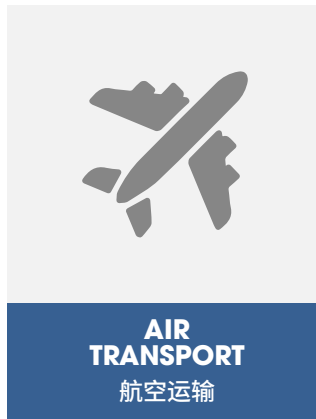
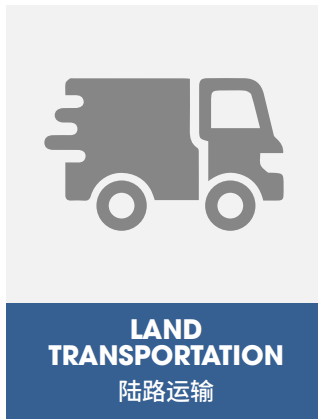

CONTACT INFORMATION 联系方式

◆ **From:** : ESS COLLEGE
公司: GMB

◆ **Tel:** +86-18512006111
电话: +86-18512006111

◆ **Add:** ShangYan Road ,YuanZhou Ave.,YuanZhou Town,HuiZhou City,
GuangDong Province,P.R.C

地址: 广东省惠州市袁州镇袁州大道上燕路