

## EPS

消防应急电源

## 38.4V52AH

### INTRODUCE 简介

The centralized power supply for fire emergency lighting is a kind of backup power supply equipment, which provides power guarantee for emergency lighting equipment to ensure that the on-site lighting equipment can operate normally in emergency situations such as fire.

Provide a long-term backup power supply to meet the needs of the emergency lighting system.

消防应急照明集中电源是一种备用电源设备，为应急照明设备提供电力保障，以确保在火灾等紧急情况下，现场照明设备能够正常运行。提供较长时间的备用电源，以满足应急照明系统的使用需求。

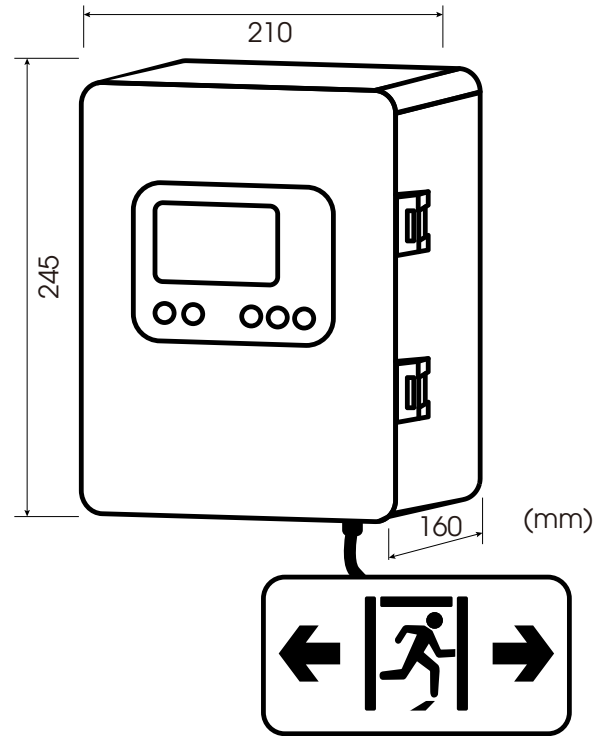

### FEATURES & BENEFITS 功能和优点

- ◆ **Overload protection**  
过载保护
- ◆ **Overvoltage protection**  
过压保护
- ◆ **Low voltage protection**  
低压保护
- ◆ **Short circuit protection**  
短路保护
- ◆ **Self-test function**  
自检功能
- ◆ **Strong anti-interference system**  
强大的抗干扰系统
- ◆ **Easy to install**  
易于安装

### APPLICATION SCENARIO 应用场景

- ◆ **Shopping mall**  
商场
- ◆ **Gym**  
体育场馆
- ◆ **Office building**  
写字楼
- ◆ **Hotel**  
酒店
- ◆ **Hospital**  
医院
- ◆ **School**  
学校
- ◆ **Subway**  
地铁
- ◆ **Tunnel**  
隧道
- ◆ **Factory**  
工厂
- ◆ **Station**  
车站
- ◆ **Airport**  
机场

## SPECIFICATIONS 规格 MODEL:38.4V52AH

Battery type 电池类型	LiFePO4
Cell model 电芯型号	IFR328007.5Ah
Rated voltage 额定电压	38.4V
Nameplate capacity 额定容量	52Ah
Voltage range 电压范围	30V~43.8V
Power 功率	1996.8W
Standard charging current 标准充电电流	0.5C
Standard discharge current 标准放电电流	0.5-1C
Number of cycles 循环次数	2000
Shell material 外壳材质	Epoxy resin board+PVC 环氧树脂板+PVC
Weight 重量	13.4Kg

## APPEARANCE SPECIFICATION 外观规格

Dimension( L x W x H mm ) 尺寸(长 x 宽 x 高 mm)	245 x 210 x 160 mm
---	--------------------

## WORKFLOW 工作流程

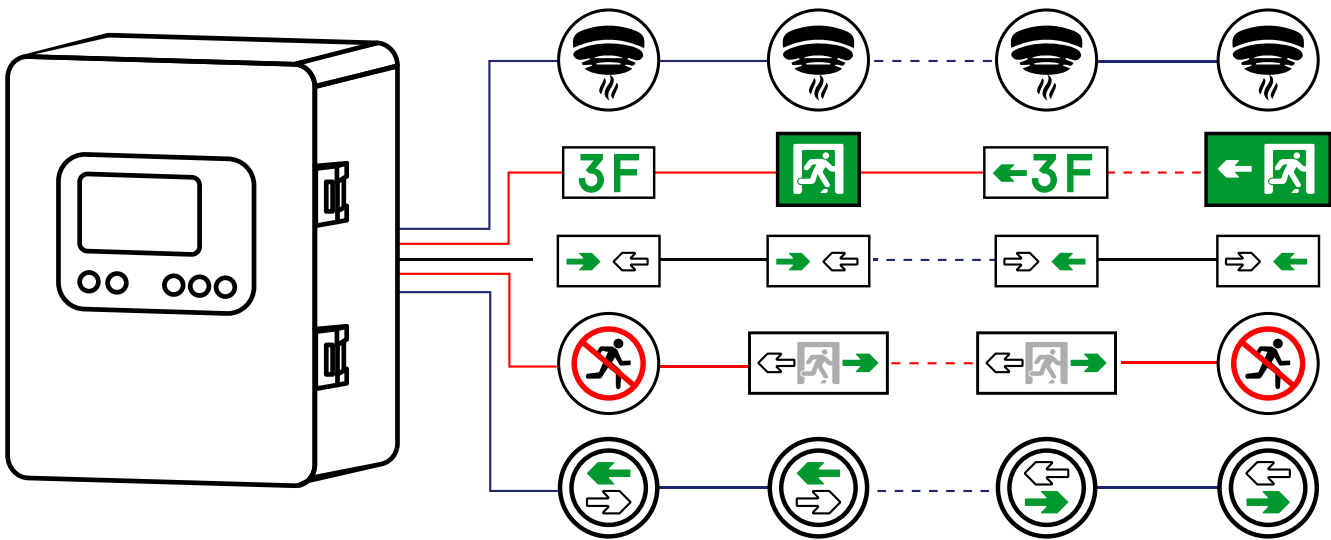

## AUTHENTICATION 认证



IECEX



ATEX

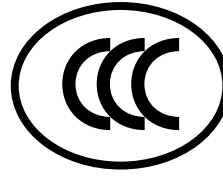

CCC EXPLOSION  
PROOF CERTIFICATION

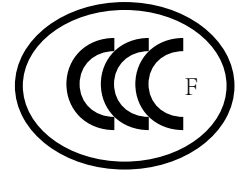

CCC FIRE  
CERTIFICATION

## STORAGE 储存

- ◆ The centralized power supply for fire emergency lighting should be stored in a dry, ventilated room without direct sunlight, away from heat sources, water sources, flammable and explosive materials, etc., to prevent safety accidents.  
消防应急照明集中电源应储存在干燥、通风、无阳光直射的室内，远离热源、水源、易燃易爆物品等，以防发生安全事故。
- ◆ The storage temperature of the centralized power supply for fire emergency lighting should generally be between 15 degrees Celsius and 30 degrees Celsius, and avoid long-term storage in high or low temperature environments.  
消防应急照明集中电源的储存温度一般在15摄氏度~30摄氏度之间，避免长时间储存在高温或低温环境中。
- ◆ The centralized power supply for fire emergency lighting should be charged during storage to ensure that the battery is in the best condition. At the same time, the charging status of the battery should be checked regularly, and the battery should be replenished in time.  
消防应急照明集中电源在储存时应处于充电状态，以保证电池处于最佳状态。同时，应定期检查电池充电状态，及时补充电量。
- ◆ For the centralized power supply of fire emergency lighting with battery, it is recommended to charge it every 1-2 months when not in use, so as to prevent the battery from excessive self-discharge and cause capacity reduction. The shelf life is generally about two years.  
针对带蓄电池的消防应急照明集中电源，建议在不使用时每隔1-2个月充电一次，以防止电池自放电过度而导致容量减少。保质期一般为两年左右。
- ◆ The storage environment of the centralized power supply for fire emergency lighting should be protected to avoid dust, debris deposition or moisture infiltration. For relatively large equipment, it should be regularly checked, cleaned and dust-proof to keep the hardware in a stable working state.  
消防应急照明集中电源的储存环境应进行防护，避免灰尘、杂物沉积或者湿气渗入，对于比较大的设备应定期进行检查、清洁防尘保持硬件的稳定工作状态。

## USE SAFETY 使用安全

- ◆ The centralized power supply for fire emergency lighting should be installed, repaired and maintained by technical personnel with corresponding qualifications and experience. Do not disassemble, change or replace accessories without authorization, so as not to affect its normal use function and performance.  
消防应急照明集中电源应由具备相应资质和经验的技术人员安装、维修和保养。不得私自拆卸、改变或更换配件，以免影响其正常使用功能和性能。

- ◆ The centralized power supply for fire emergency lighting should be used in a dry, ventilated equipment room without direct sunlight, and should be kept away from places such as oxygen, flammable and explosive materials, etc. At the same time, it should be moisture-proof, dust-proof, and anti-static.

消防应急照明集中电源应在干燥、通风、无阳光直射的设备房中使用, 并应远离氧气、易燃易爆物品等场所, 同时, 应防潮、防尘、防静电等。

- ◆ For the centralized power supply of fire emergency lighting, the battery capacity test should be carried out regularly to prevent the power reduction caused by battery aging. At the same time, the working conditions of the power supply itself should be checked regularly, especially the self-test function and alarm prompt function to ensure the reliability and safety of the work.

对消防应急照明集中电源应该定期进行电池容量测试, 防止电池老化引起电量缩减。同时, 还应定期检查电源本身的工作情况, 特别是自检功能和报警提示功能, 确保工作的可靠性和安全性。

- ◆ For the centralized power supply of fire emergency lighting with batteries, attention should be paid to the charging status of the batteries during use to avoid excessive discharge and charging to prolong the life of the batteries. When it is found that the battery needs to be replaced, it should be replaced with a product equivalent to the original battery.

对于带蓄电池的消防应急照明集中电源, 应在使用时注意电池充电状态, 避免过度放电和充电, 以延长电池的寿命。当发现电池需要更换时, 应使用与原电池等同的产品进行更换。

- ◆ Carry out maintenance according to the specified cycle, clean the parts of the power supply itself and conductive parts such as capacitors and windings, so as to ensure the safe and reliable use of the power supply.

按照规定周期进行检修, 对电源本身的部件和电容器、绕组等导电部件进行清洗, 确保电源安全可靠地使用的需要。

## TRANSPORT 运输

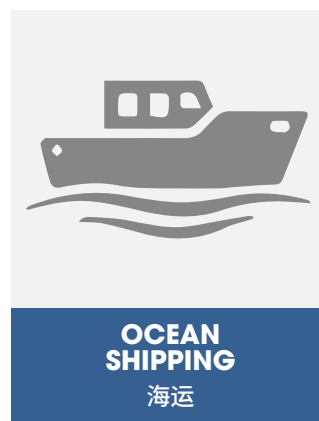
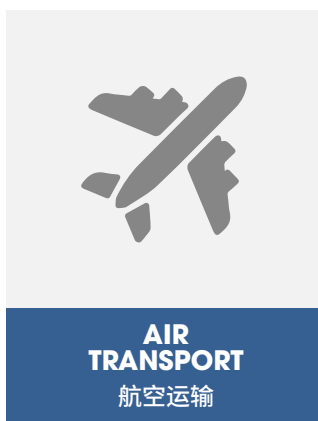
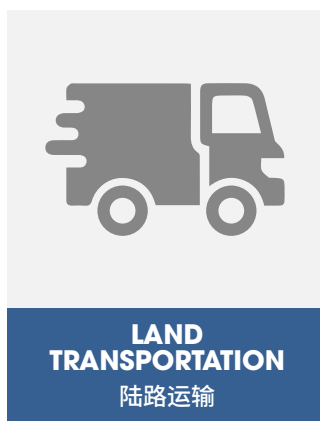

## CONTACT INFORMATION 联系方式

- ◆ **From:** ESS COLLEGE  
公司: ESSC

- ◆ **Tel:** +86-18512006111  
电话: +86-18512006111

- ◆ **Add:** ShangYan Road ,YuanZhou Ave.,YuanZhou Town,HuiZhou City,  
GuangDong Province,P.R.C

地址: 广东省惠州市袁州镇袁州大道上燕路